

DH-PFH610V Series

14" Vandal-proof Housing



Features

- 14" housing, provides all-weather protection for box cameras and lens;
- All-aluminum shell design, IP67, IK10, 14" housing with different function modules: Built-in heating and cooling system, windows adopt water-proof films, 0-100m IR, built-in PoE module and support remote control of IR light by RS485;
- Aesthetic design.

Technical Specifications

Model	PFH610V	PFH610V-H	PFH610V-H-POE	PFH610V-IR	PFH610V-IR-POE
General					
Inside Dimension (LxWxH)	215x90x83mm (8.46"x3.54"x3.27")	255x90x70.5mm(10.04"x3.54"x2.78") 215x90x83mm(8.46"x3.54"x3.27")			
Window Dimension	φ60mm(φ2.36")				
Operating Temperature	Set	-30°C ~+60°C (-22°F ~+140°F)	-40°C ~+60°C(-40°F ~+140°F)		
	Heater	N/A	ON: 5±5 °C /OFF: 15±5 °C		ON: <+5°C(+41°F) /OFF: ≥+5°C(+41°F)
	Cooler	N/A	ON: 37±5 °C /OFF: 20±5 °C ON: 5±5 °C /OFF: 15±5 °C		ON: ≥37°C(98.6°F) /OFF: <20°C(68°F)
IR Distance	N/A		0~100m(0~328.08ft)		
RS485 Control	N/A		Yes, use RS485 to control IR light		
Power Supply	DC12V, AC24V (just for camera)	AC24V/3A	POE+	AC24V/5A	POE+
Power Consumption (without camera)	N/A	30W	12W	55W	12.5W
Environmental					
Operating Temperature	-30°C ~60°C (-22°F ~+140°F)	-40°C ~60°C (-40°F ~+140°F)			
Humidity	<90% RH				
Ingress Protection	IP67				
Vandal Resistance	IK10				
Corrosion Protection	N/A				
Construction					
Material	Aluminum(case)&PC(others)				
Dimension(LxWxH)	404mmx164mmx132mm(15.91"x6.46"x5.2")				
Weight	2.5kg(5.51lb)	2.7kg(5.95lb)	3.0kg(6.61lb)	3.0kg(6.61lb)	3.2kg(7.05lb)
Others					
Certification	CE, FCC, ICES	CE, FCC, UL, EAC, ICES	CE, FCC	CE, FCC, UL, EAC, ICES	CE, FCC, ICES
Applicable Model	Please see "Accessory Selection"				

Order Information

Type	Part Number	Description
Housing Series	DH-PFH610V	14" vandal-proof housing, IP67, IK10, without any modules
	PFH610V	14" vandal-proof housing, IP67, IK10, without any modules
	DH-PFH610V-H	14" vandal-proof housing, IP67, IK10, heater
	PFH610V-H	14" vandal-proof housing, IP67, IK10, heater
	DH-PFH610V-H-POE	14" vandal-proof housing, IP67, IK10, heater, POE+
	PFH610V-H-POE	14" vandal-proof housing, IP67, IK10, heater, POE+
	DH-PFH610V-IR	14" vandal-proof housing, IP67, IK10, heater, IR
	PFH610V-IR	14" vandal-proof housing, IP67, IK10, heater, IR
	DH-PFH610V-IR-POE	14" vandal-proof housing, IP67, IK10, heater, IR, POE+
	PFH610V-IR-POE	14" vandal-proof housing, IP67, IK10, heater, IR, POE+
Optional Brackets	PFB604W	Wall-mount bracket
	PFB601W	Plane-mount bracket
	PFB600W	Ceiling-mount bracket
	PFA162	Support three-axis rotation for housing installation

Dimensions (mm/inch)

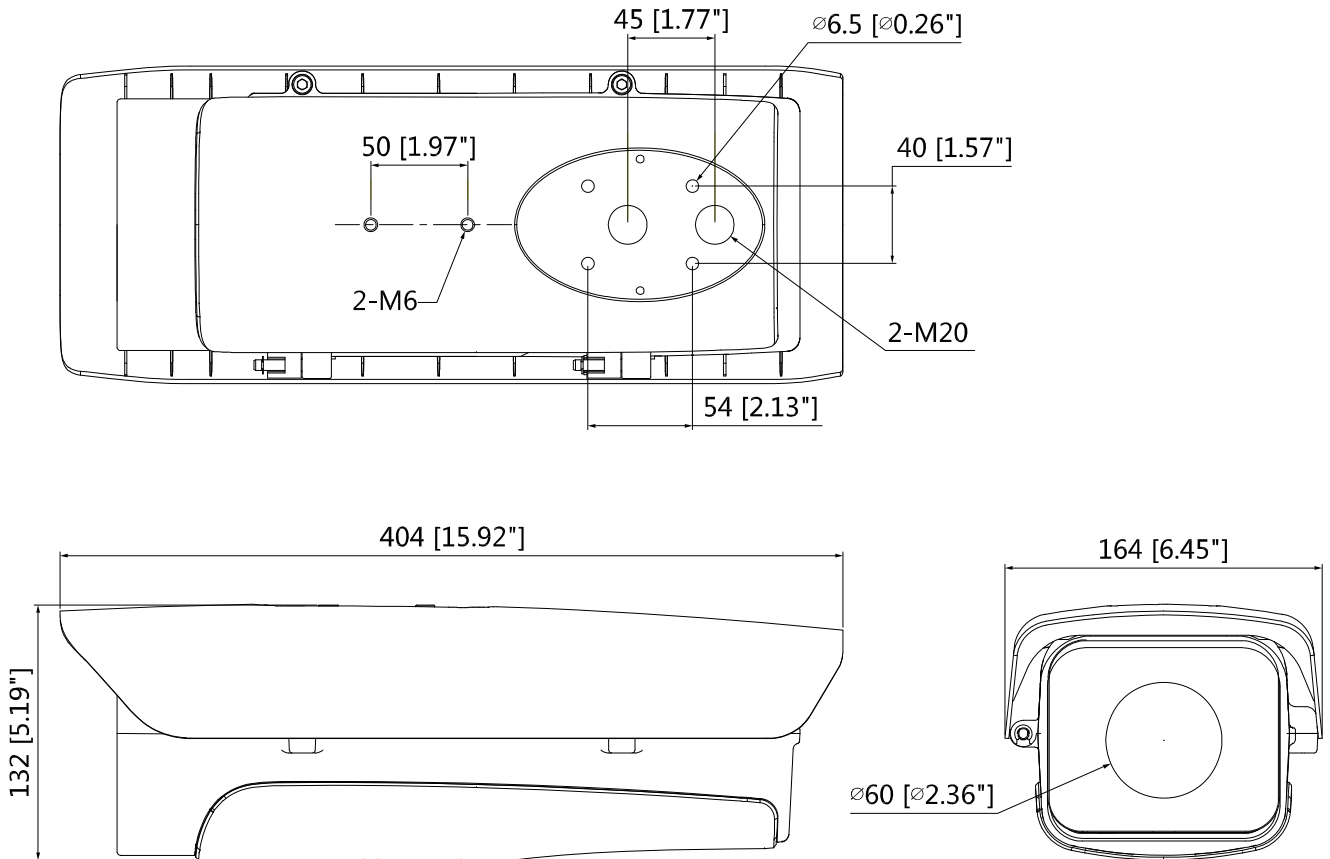

Application



Package Information

PFH610V

- 14" vandal-proof housing *1
- Installation instruction *1
- M20 water joint *2
- 1/4/20×8UNC screw *2
- S5.0 wrench *1

PFH610V-H

- 14" vandal-proof IR housing *1
- Installation instruction *1
- M20 water joint *2
- 1/4/20×8UNC screw *2
- S5.0 wrench *1
- Connecting line(link camera to IR driver board) *1

PFH610V-H-POE

Bag 1:

- 14" vandal-proof POE housing *1
- Installation instruction *1
- M20 water joint *2
- 1/4/20×8UNC screw *2
- S5.0 wrench *1
- Connecting line(link POE board to temperature control board) *1

Bag 2:

- 1/4/20×8UNC screw *1
- Temperature control board *1

PFH610V-IR

- 14" vandal-proof IR housing *1
- Installation instruction *1
- M20 water joint *2
- 1/4/20×8UNC screw *2
- S5.0 wrench *1
- Connecting line(link camera to IR driver board) *1

PFH610V-IR-POE

- 14" vandal-proof IR POE housing *1
- Installation instruction *1
- M20 water joint *2
- 1/4/20×8UNC screw *2
- S5.0 wrench *1
- Connecting line(link camera to IR driver board) *1
- Network cable(link camera to POE power module) *1
- Terminal block *1